



Przekroje techniczne

IDEAL **4000**
IDEAL **5000**
IDEAL **7000 NEW**
IDEAL **8000**
BLOCKPROFIL **NL**

STREAMLINE **76**
BLUEEVOLUTION **92**

EKOSUN **70**
EKOSUN **6**
EKOSUN **7**

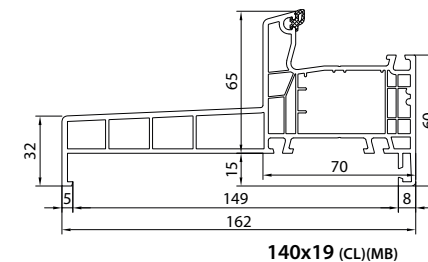
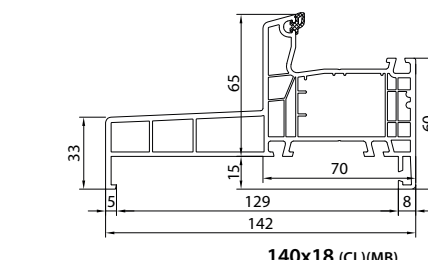
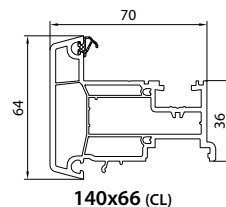
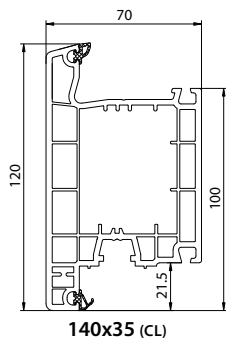
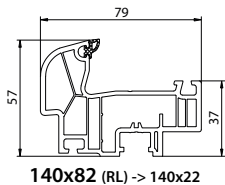
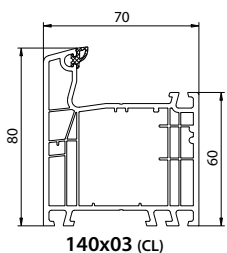
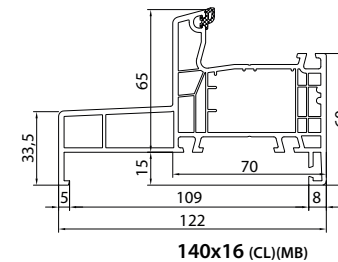
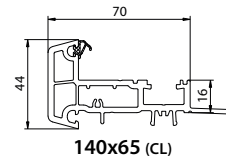
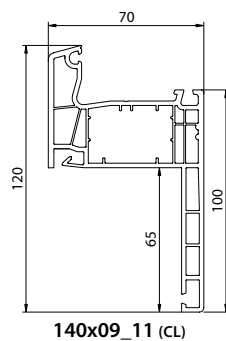
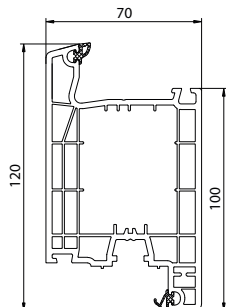
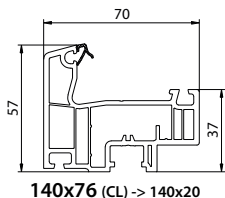
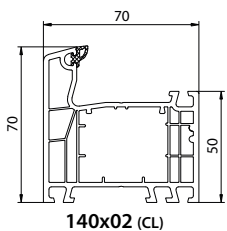
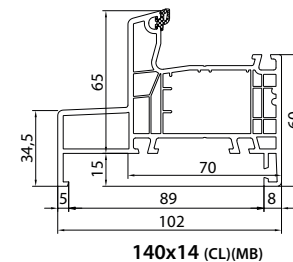
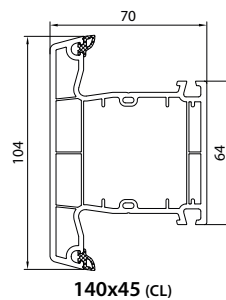
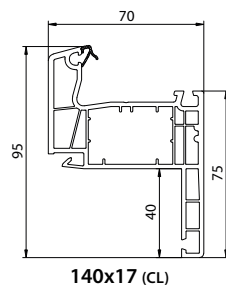
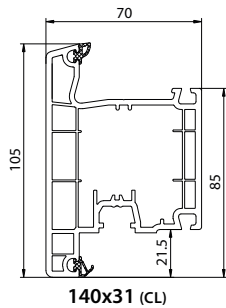
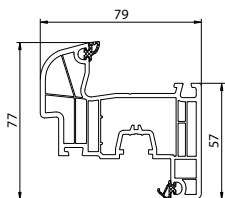
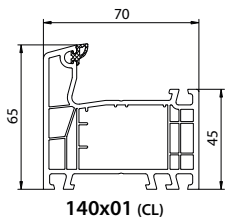
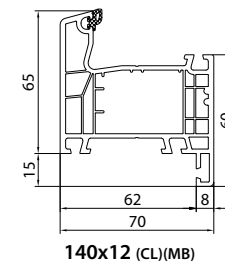
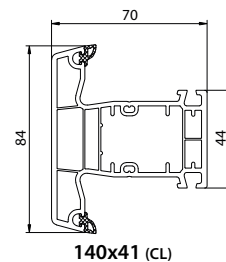
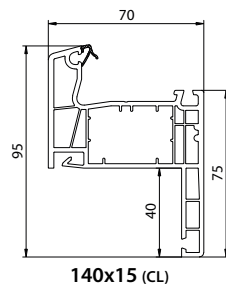
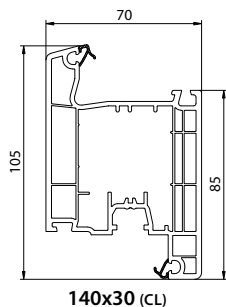
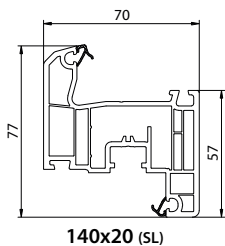
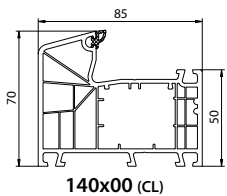

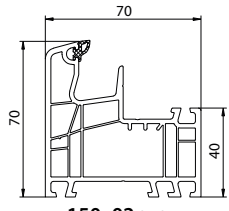

150x02 (CL)

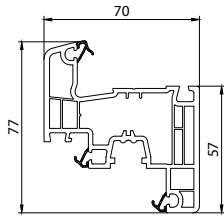

150x20 (CL)

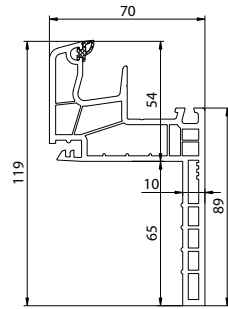

150x10 (CL)

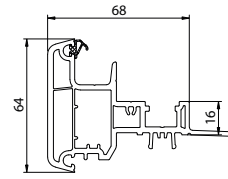

150x65 (CL)

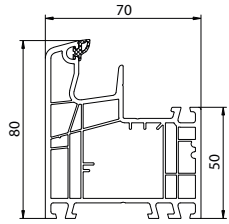

150x03 (CL)

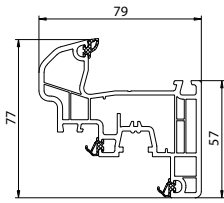

150x26 (CL)

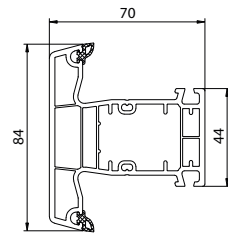

140x41 (CL)

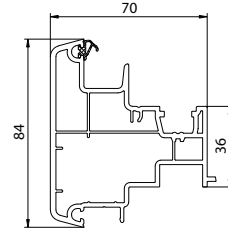

150x67 (CL)

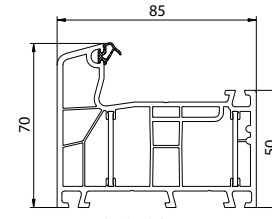

070x02 (CL)

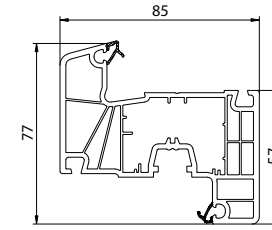

170x20 (CL)

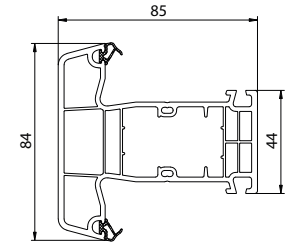

170x41 (CL)

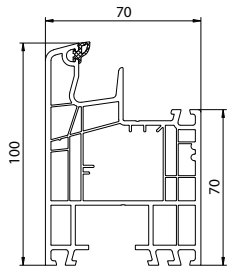

150x04 (CL)

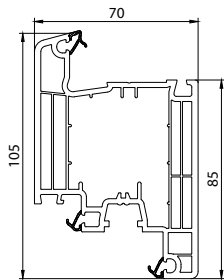

150x30 (CL)

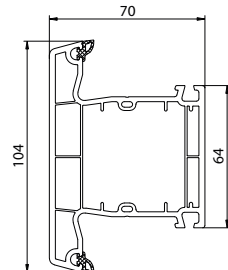

140x45 (CL)

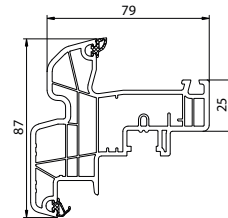

150x69 (CL) -> 150x26

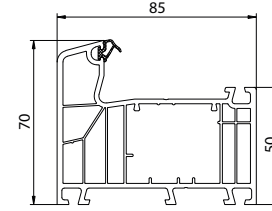

170x02 (CL)

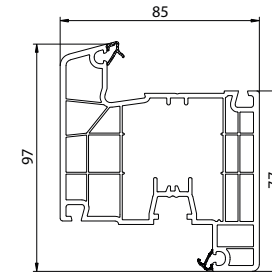

170x30 (CL)

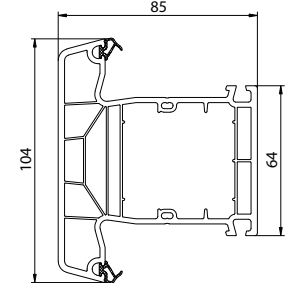

170x44 (CL)

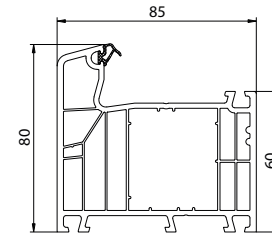

170x03 (CL)

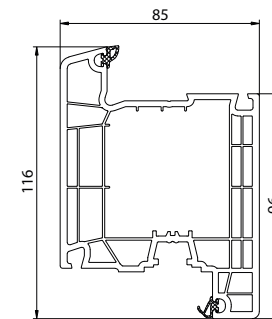

170x33 (CL)

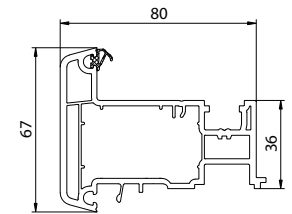

170x64 (CL)

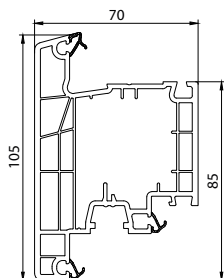

150x31 (CL)

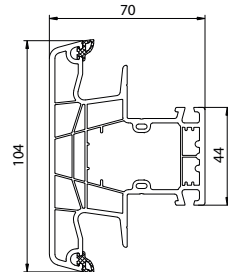

150x43 (CL)

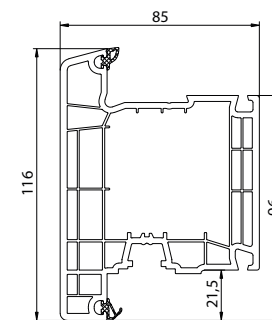

170x35 (CL)

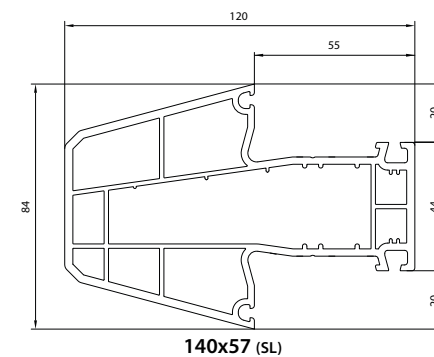
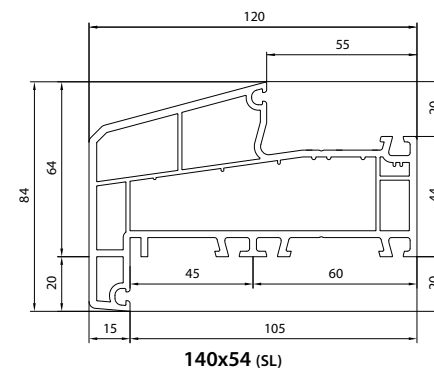
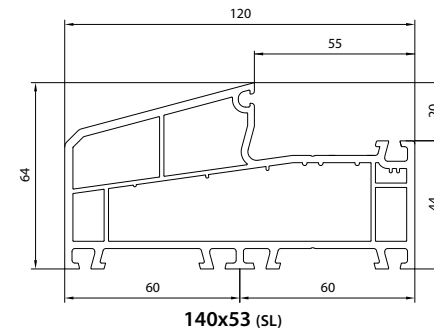
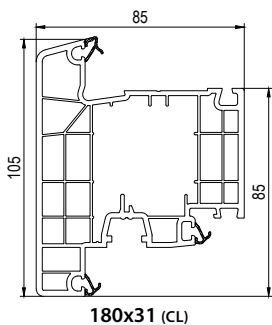
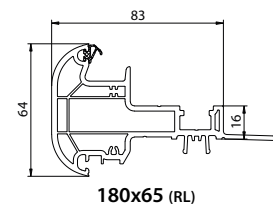
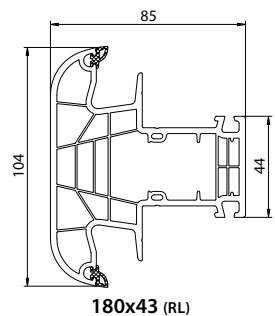
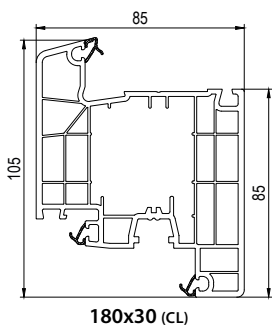
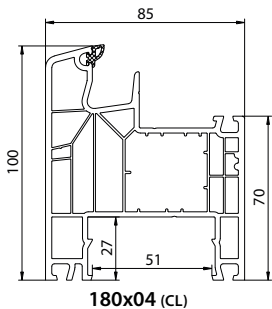
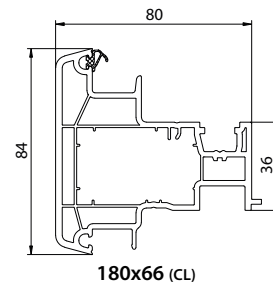
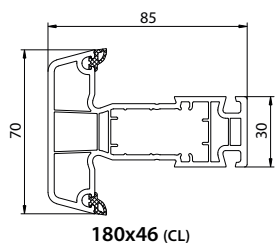
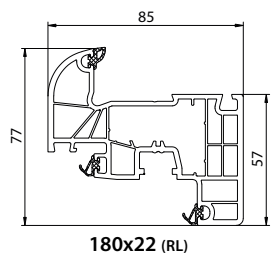
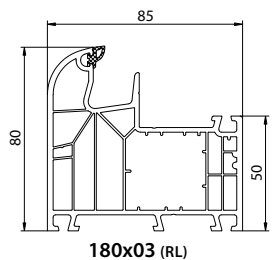
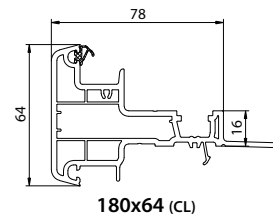
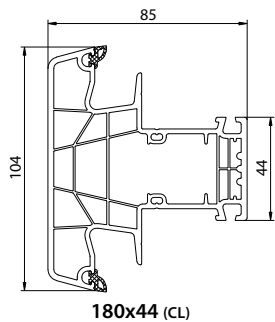
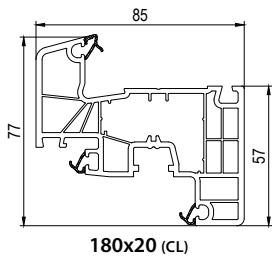
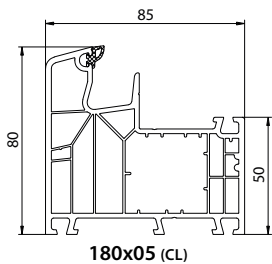

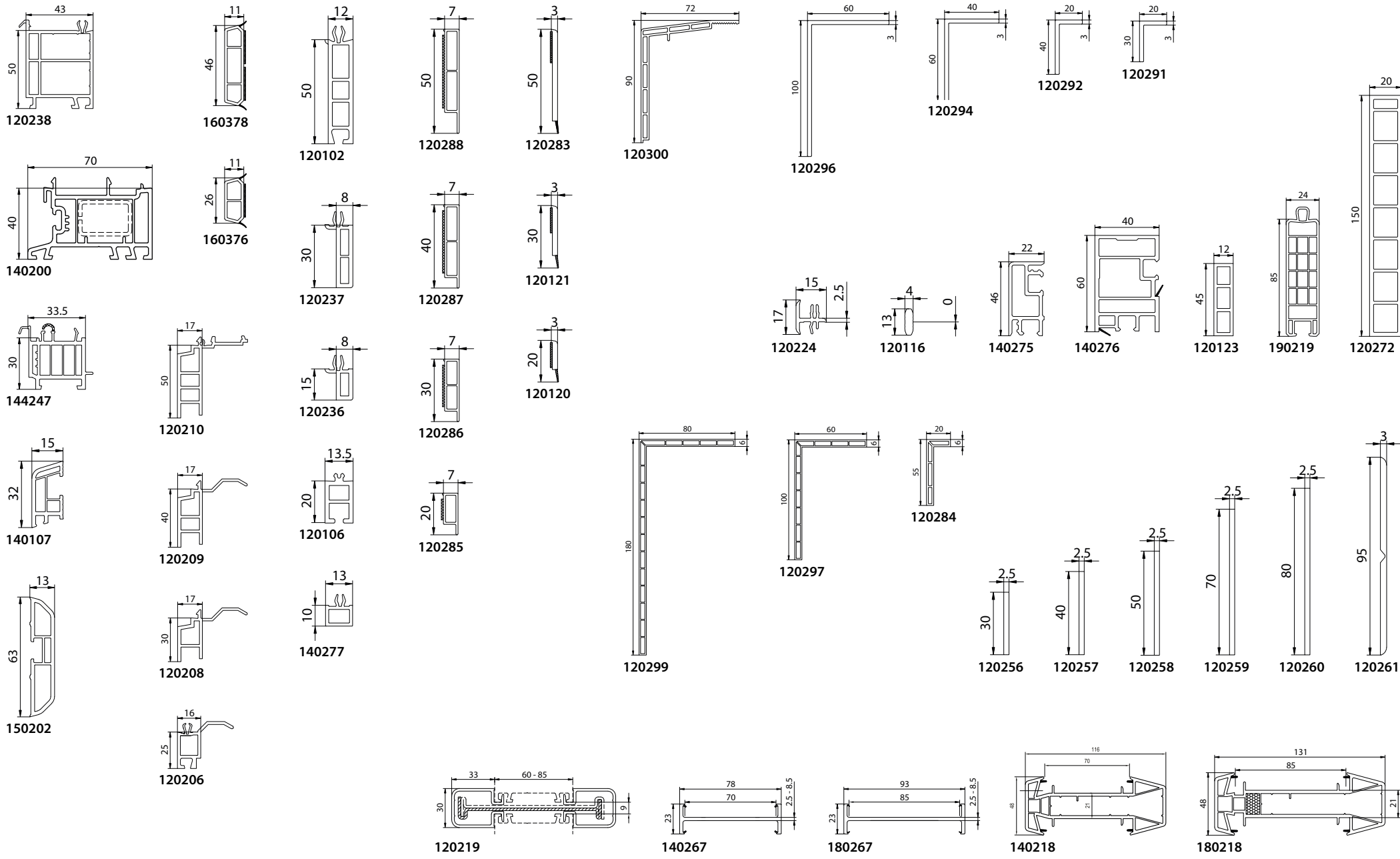

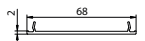

140227

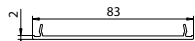

180227

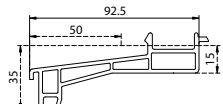

120246

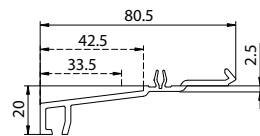

140229

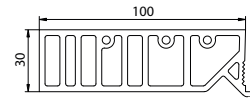

120112

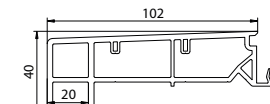

120196

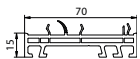

140209

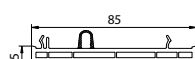

180209

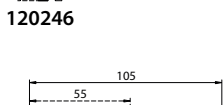

120248

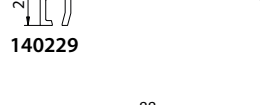

110200

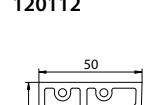

120113

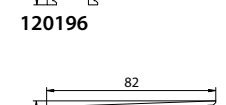

120270

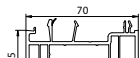

140205

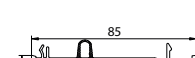

180201

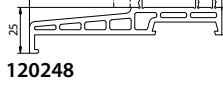

120249

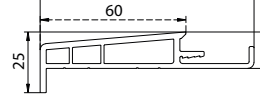

140219

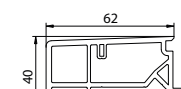

120195



650921

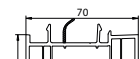

140207



180203

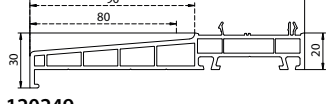

140238

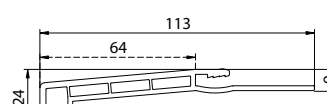

120190

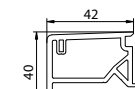

120194

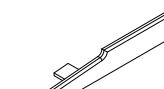

620249

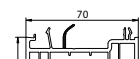

140208

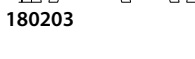

180204

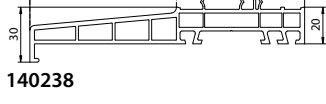

100220

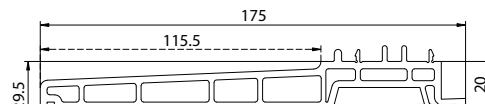

120192

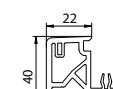
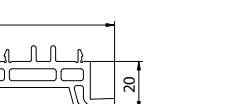

120193

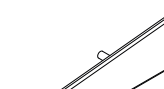

600220

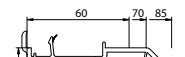

140248



140243

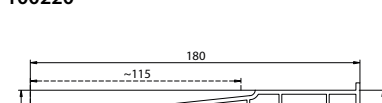

120108

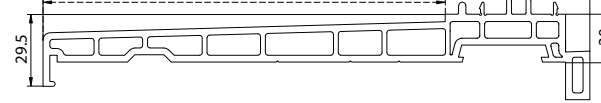

120109



650902



140249



140244



100090 (CL)

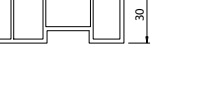

100097 (CL)



100092 (CL)



100098 (CL)



100070 (CL)

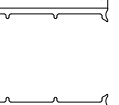

100072 (CL)

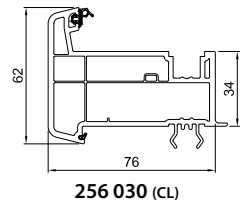
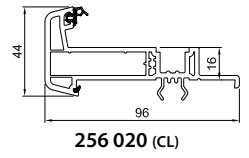
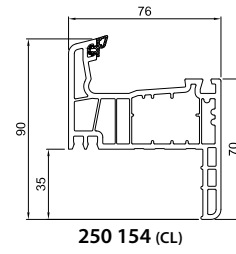
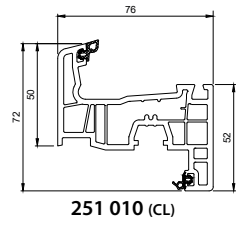
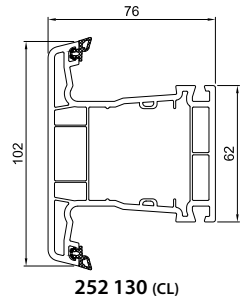
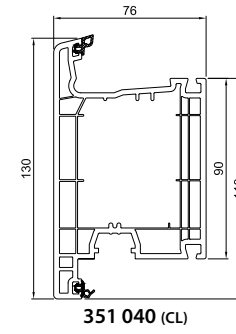
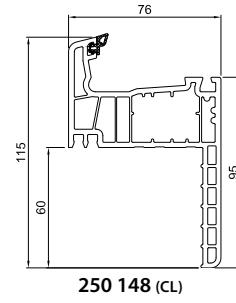
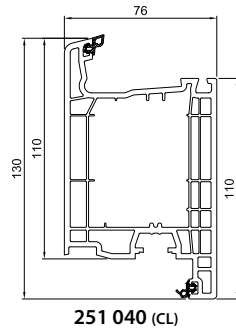
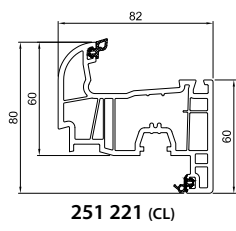
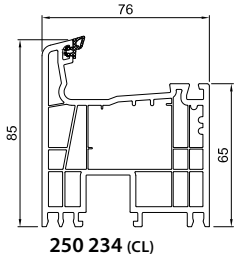
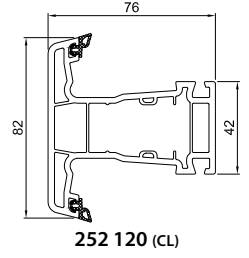
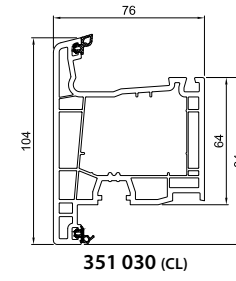
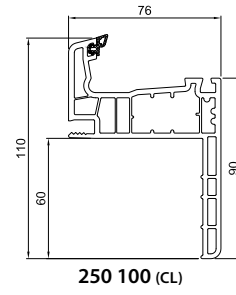
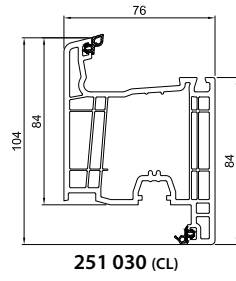
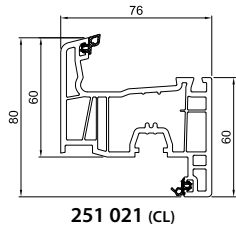
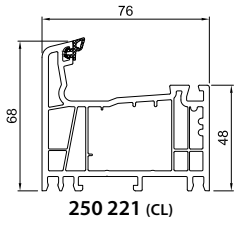

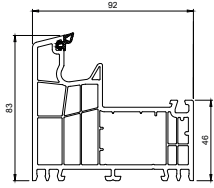

170 820 (CL)

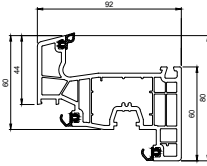

171 020 (CL)

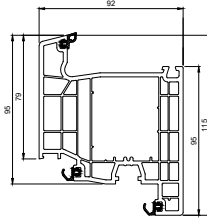

171 030 (CL)

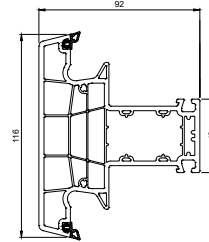

172 420 (CL)

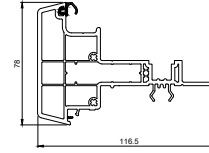

176 020 (CL)

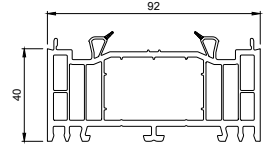

476 164

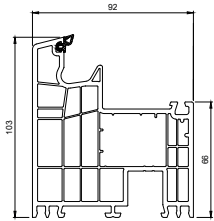

170 430 (CL)

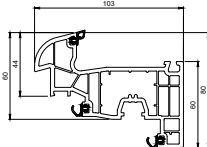

171 226 (CL)

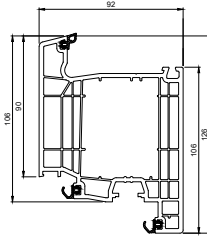

171 040 (CL)

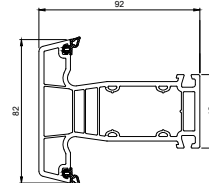

172 425 (CL)

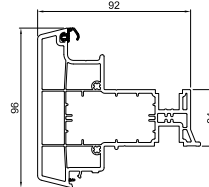

176 030 (CL)

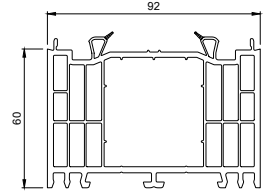

476 170

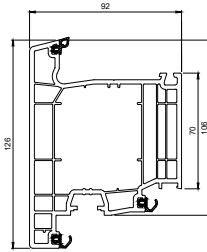

371 040 (CL)

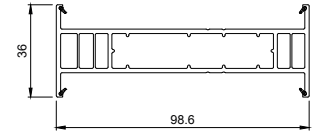

476 273

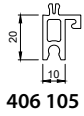

406 105

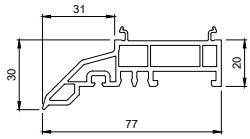

416 126

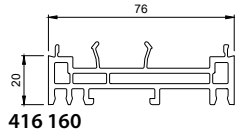

416 160

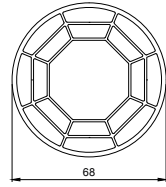

NP0160

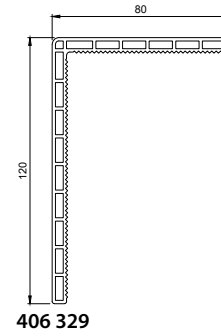

406 329

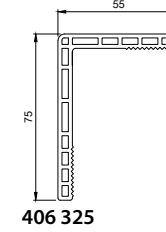

406 325

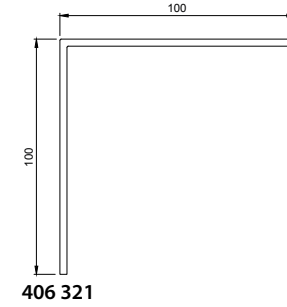

406 321

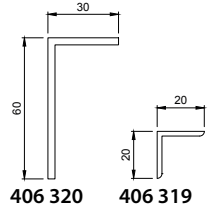

406 320

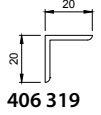

406 319

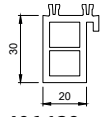

406 139

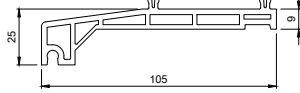

406 115

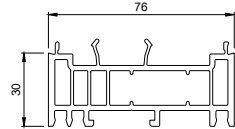

416 163

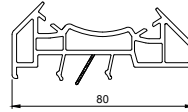

416 251

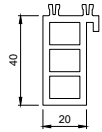

406 140

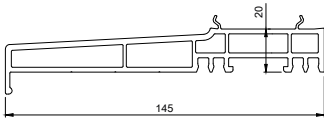

416 110

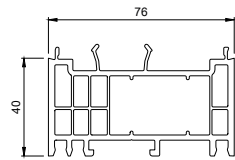

416 164

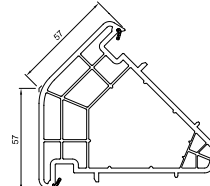

416 240

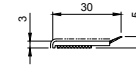

406 312

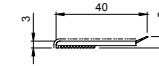

406 315

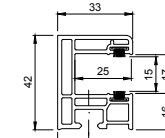

406 073

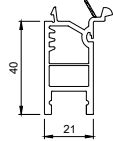

416 142

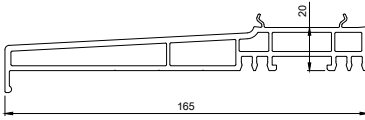

416 115

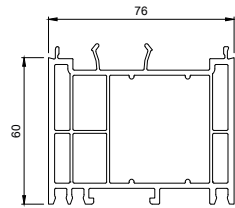

416 170

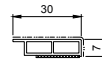

406 345
(640 736)

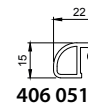

406 051

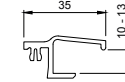

406 053

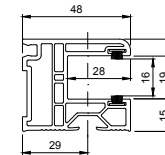

416 086

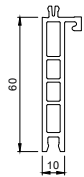

406 157

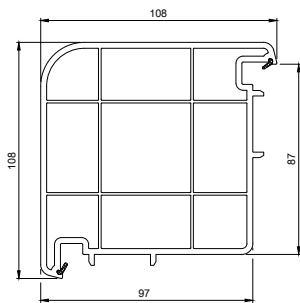

416 210

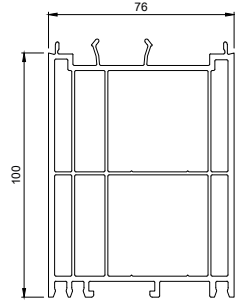

416 176

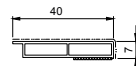

(640 746)

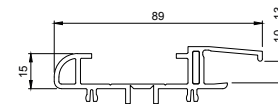

416 054

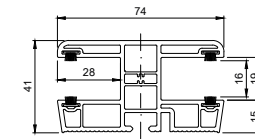

416 096

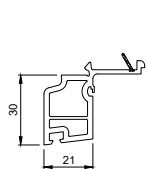

416 133

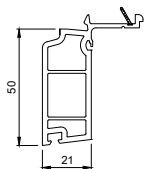

416 135



406 255

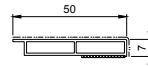

406 350
(640 756)

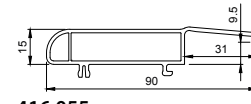

416 055

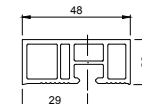

406 081

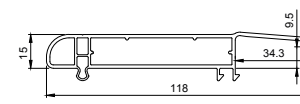

476 055

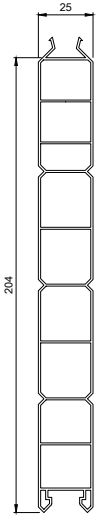

406 670

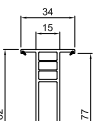

416 273

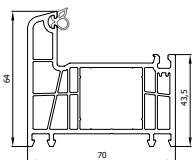

7110

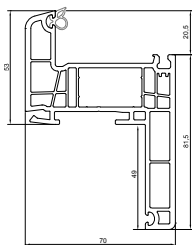

7113

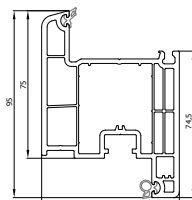

7126

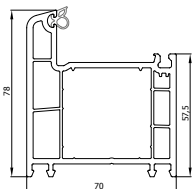

7112

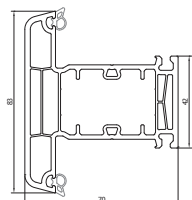

7230

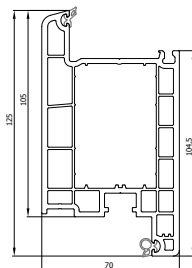

7124

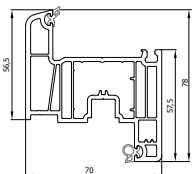

7120

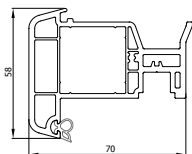

7232

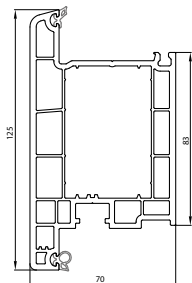

7125

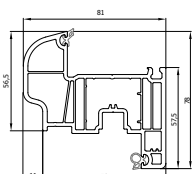

7121

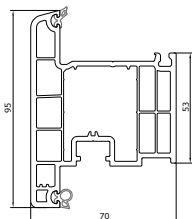

7127

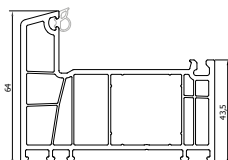

8210

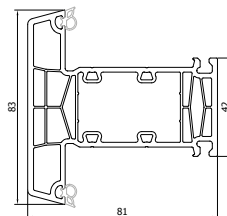

8230

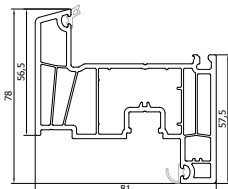

8220

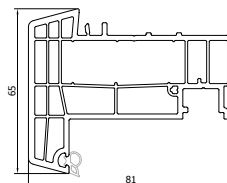

8232

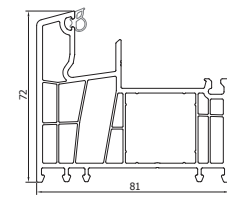

8312

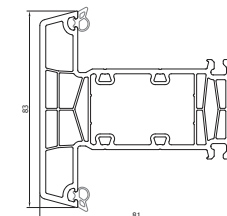

8230

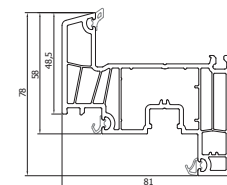

8320

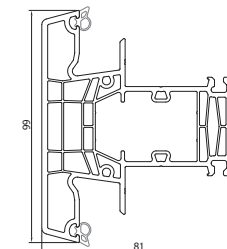

8330

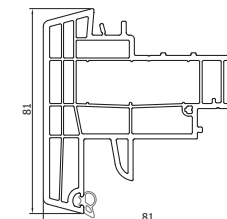

8332

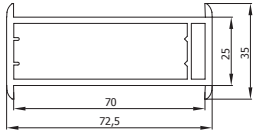

7053-00



6050-00

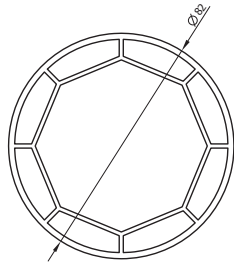

7054-00

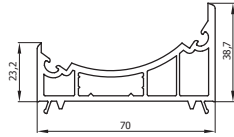

7055-00

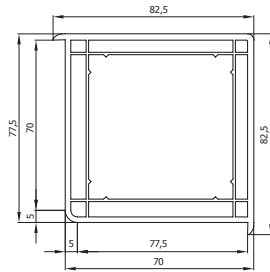

7052-00

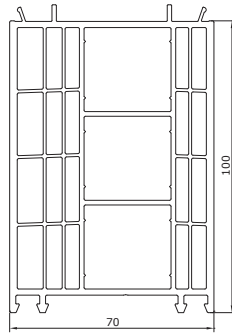

7059-00

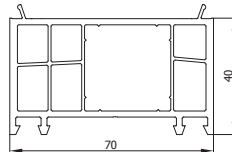

7051

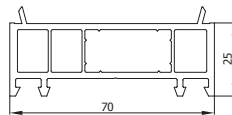

7058

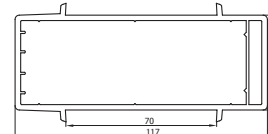

7056-00

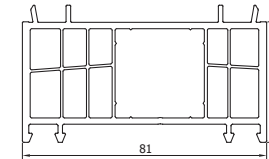

8151-00

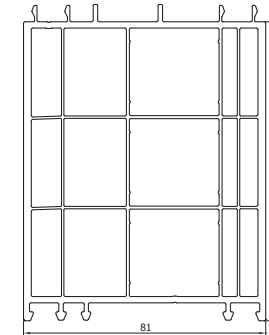

8159-00

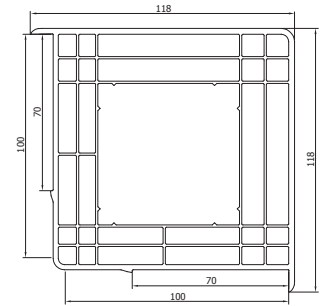

9152-00

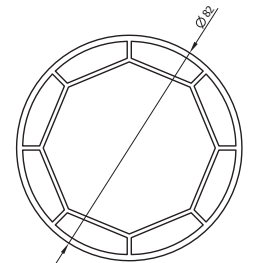

7054-00

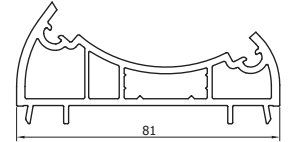

8155-00

